

POS.	CODE	DESCRIPTION	QTY
1	A6566	CLUTCH LEVER	1
2	A6567	BRAKE LEVER	1
3	A6450	LIMITING STOPPER	1
4	A6451	FOAM PIPE	1
5	A6452	UPPER HANDLE	1
6	A6453	NUT	2
7	A6454	CABLE FIXING CLAMP	1
8	A6455	BRAKE CABLE	1
9	A6456	CLUTCH CABEL	1
10	A6457	BOLT	1
11	A6458	LOWER HANDLE	1
12	A6459	BOLT	4
13	A6460	FLAT WASHER	4
14	A6461	KNOB	4
15	A6462	ROPE GUIDE	1
16	A6463	CABLE SUPPORT	1
17	A6464	BOLT	2
18	A6465	NUT	2
19	A6466	HANDLE PLUG	2

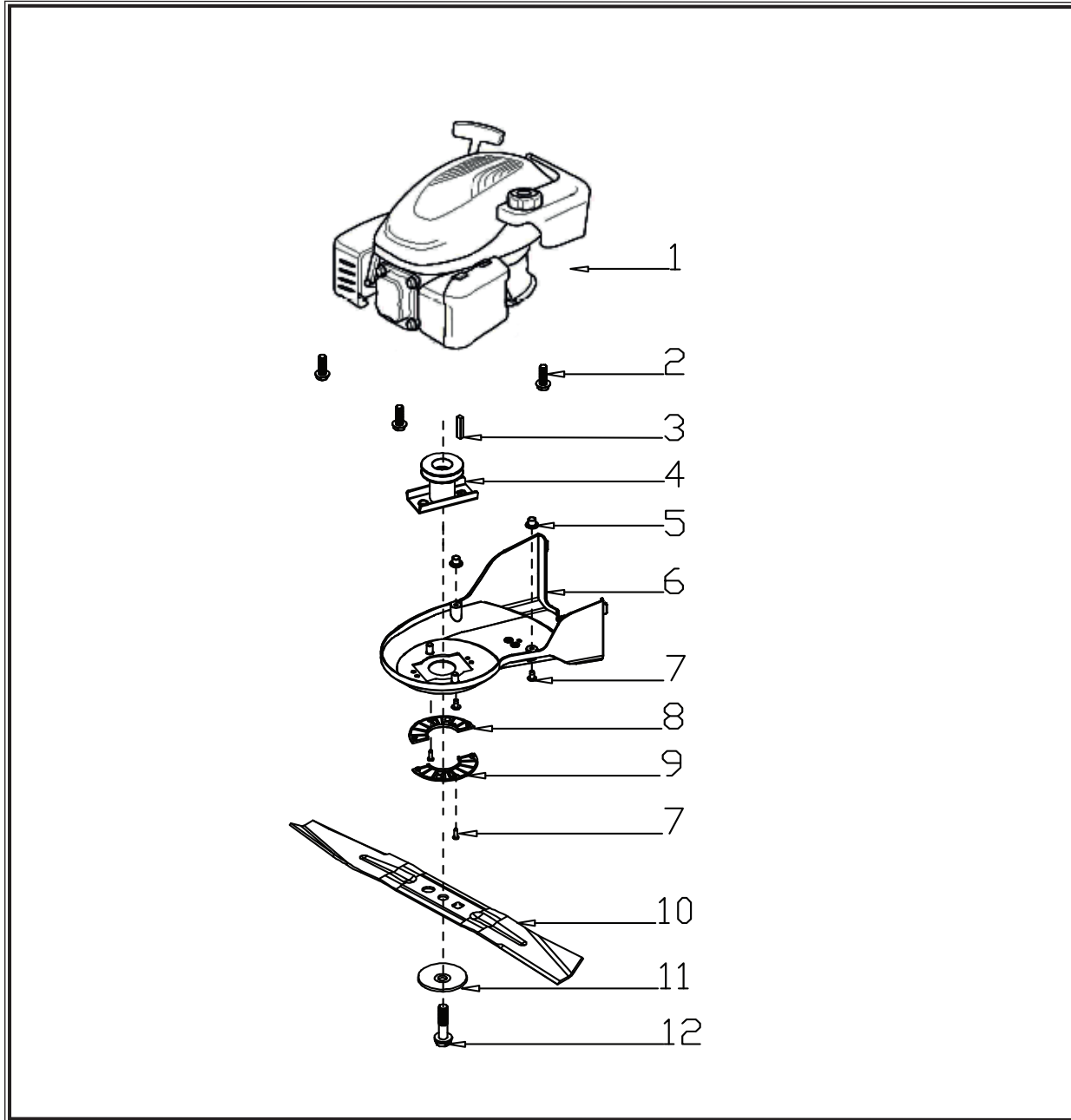

POS.	CODE	DESCRIPTION	QTY
1	46406	ENGINE RV175 (*)	1
2	A6468	BOLT	3
3	A6469	FLAT KEY	1
4	A6470	BLADE ADAPTER	1
5	A6471	SCREW CAP	2
6	A6472	BELT COVER	1
7	A6535	SCREW	4
8	A6474	BELT COVER PLATE	1
9	A6475	BELT COVER PLATE	1
10	A6476	19" BLADE	1
11	A6477	BLADE WASHER	1
12	A6478	BLADE BOLT	1

* for further information see the exploded view RV175

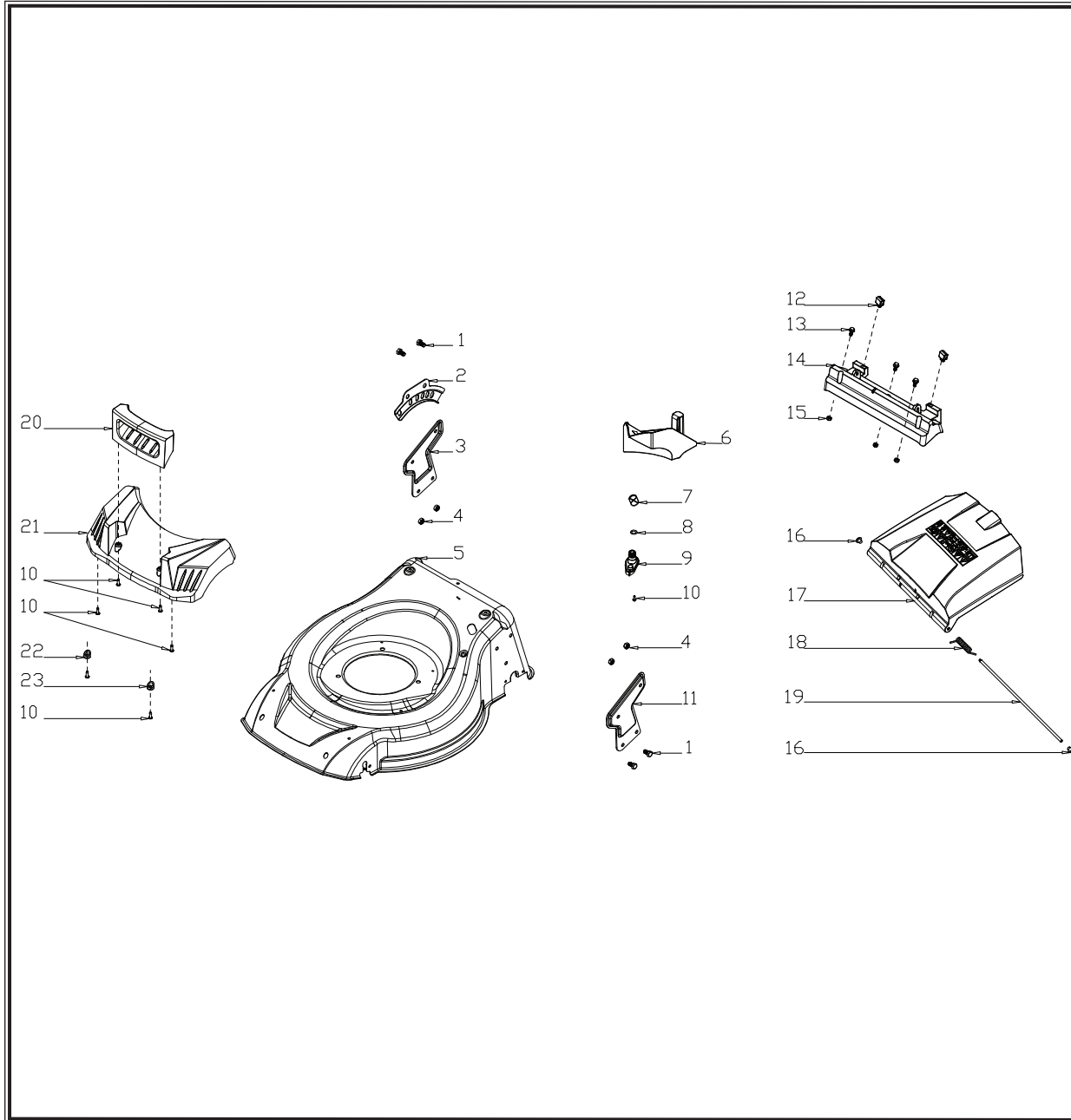

POS.	CODE	DESCRIPTION	QTY
1	A6479	BOLT	4
2	A6480	HEIGHT ADJUSTMENT PLATE	1
3	A6481	RIGHT BRACKET	1
4	A6482	NUT	4
5	A6483	DECK	1
6	A6484	MULCHING PLUG	1
7	A6485	CABLE SLEEVE	1
8	A6486	O-RING	1
9	A6487	WASHING LINKER	1
10	A6488	SCREW	7
11	A6489	LEFT BRACKET	1
12	A6490	REAR COVER SUPPORT	2
13	A6491	BOLT	3
14	A6492	REAR COVER PEDESTAL	1
15	A6525	NUT	3
16	A6494	PLUG	2
17	A6495	REAR COVER	1
18	A6496	REAR COVER SPRING	1
19	A6497	REAR COVER SHAFT	1
20	A6498	FRONT PLASTIC FACE HANDLE	1
21	A6499	FRONT PLASTIC FACE	1
22	A6500	WASHER R	1
23	A6501	WASHER L	1

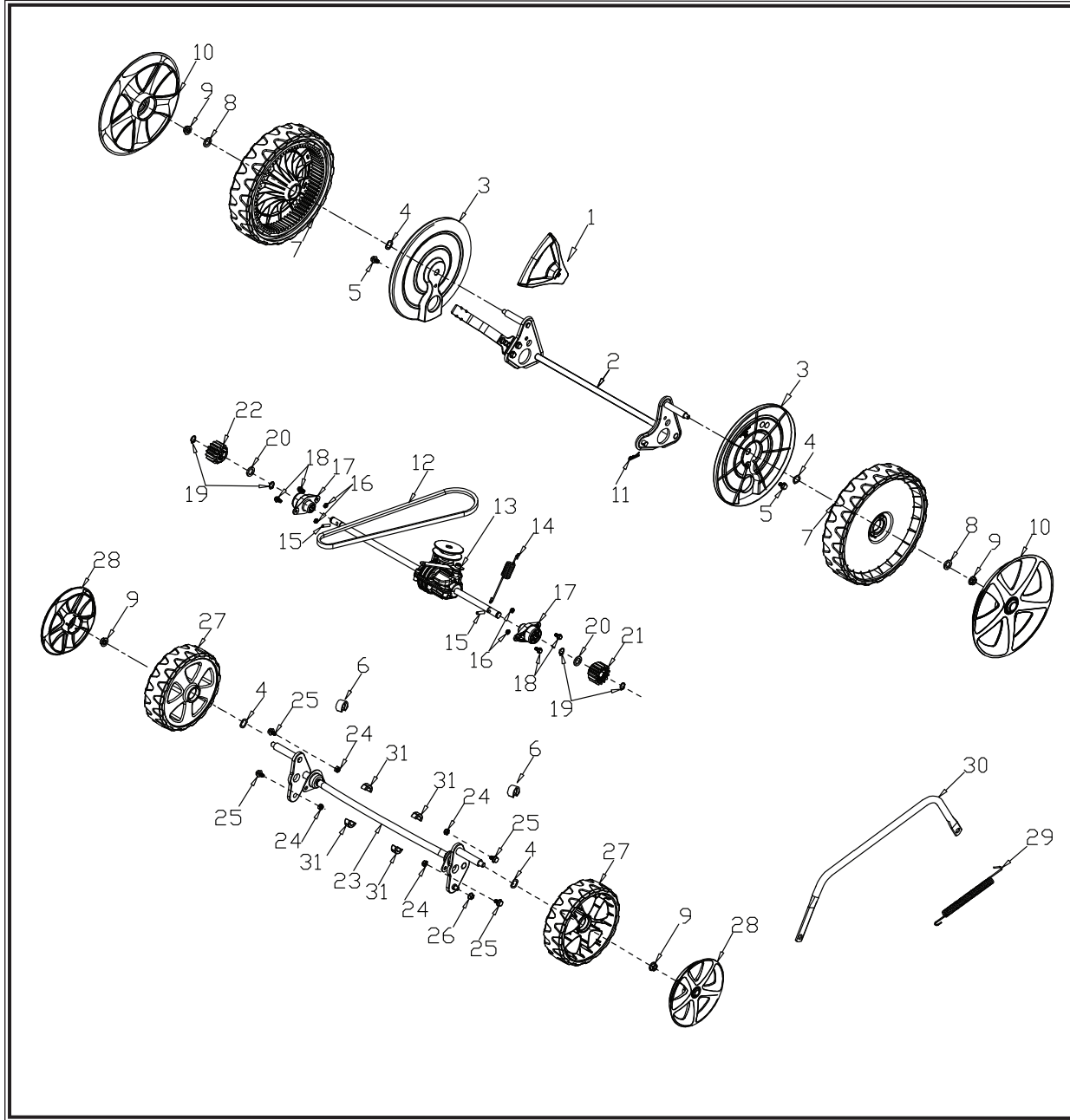

POS.	CODE	DESCRIPTION	QTY
1	A6502	HEIGHT ADJUSTMENT HANDLE	1
2	A6503	REAR WHEEL SHAFT	1
3	A6504	INNER WHEEL COVER	2
4	A6505	SPRING WASHER	4
5	A6506	BOLT	2
6	A6507	BUSH	2
7	A6508	10" WHEEL	2
8	A6509	FLAT WASHER	2
9	A6510	NUT	4
10	A6511	10" OUTER WHEEL COVER	2
11	A6512	SPLIT PIN	1
12	A6513	BELT	1
13	A6514	GEARBOX	1
14	A6515	SPRING	1
15	A6516	PIN	2
16	A6517	NUT	4
17	A6518	SHAFT SLEEVE	2
18	A6519	BOLT	4
19	A6520	LOCK RING	4
20	A6521	FLAT WASHER	2
21	A6522	LEFT GEAR	1
22	A6523	RIGHT GEAR	1
23	A6524	FRONT WHEEL SHAFT	1
24	A6525	NUT	4
25	A6506	BOLT	4
26	A6527	NUT	1
27	A6528	7" WHEEL	2
28	A6529	7" WHEEL COVER	2
29	A6530	HEIGHT ADJUSTMENT SPRING	1
30	A6531	HEIGHT ADJUSTMENT CONNECTING ROD	1
31	A6532	SHAFT SLEEVE	4

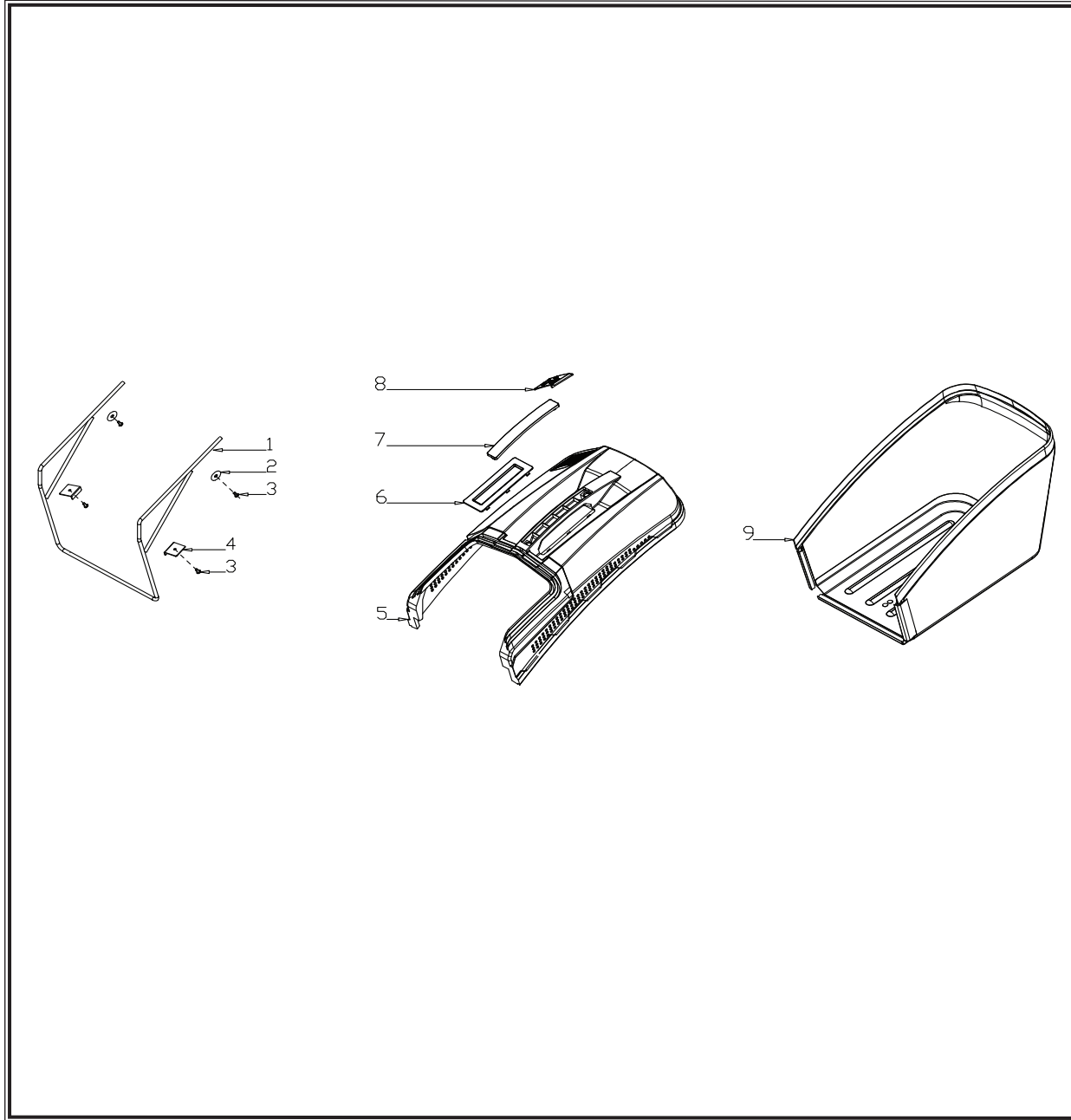

POS.	CODE	DESCRIPTION	QTY
1	A6533	METAL BRACKET	1
2	A6534	FLAT WASHER	2
3	A6535	SCREW	4
4	A6536	FIXED PLATE	2
5	A6537	PLASTIC COVER	1
6	A6538	COVER PLATE	1
7	A6539	HANDLE COVER	1
8	A6540	INDICATED BOARD	1
9	A6541	FABRIC BAG	1